

clear 70

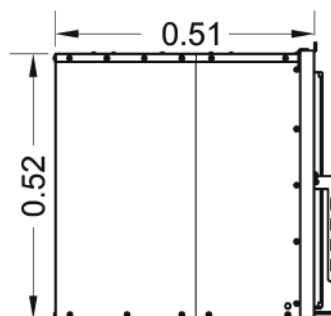
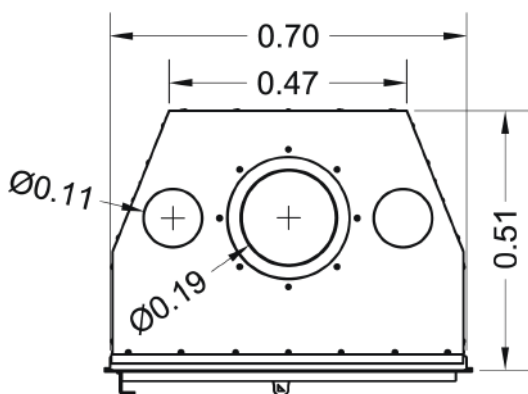
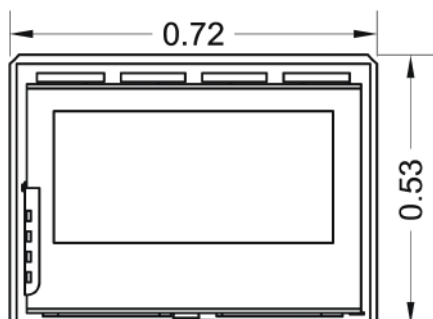

Rev. 05_2015

Τεχνικά Χαρακτηριστικά | Technical Characteristics

Διαστάσεις (Πλάτος x Βάθος x Ύψος) Dimensions (Width x Depth x Height)	72 x 54 x 53 cm
Απόδοση Efficiency	72 %
Όγκος Θέρμανσης Capacity	120 - 220 m ³
Ισχύς Power	3 - 12 kw
Κατανάλωση Ξύλου Wood Consumption	1 - 3,5 kg/h
Βεντιλατέρ Ventilator	2x 140 m ³ /h 28w
Διατομή Καμινάδας Smoke Outlet	Ø 200
Βάρος με Βερμικουλίτη Weight in Vermiculite	80 Kg
Βάρος με Μαντέμι Weight in Cast-iron	100 Kg

