

giorgia 80

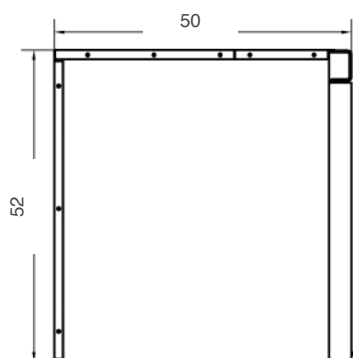
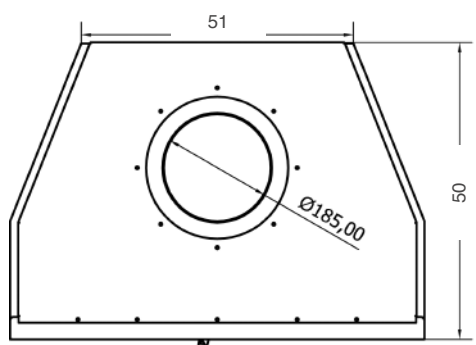
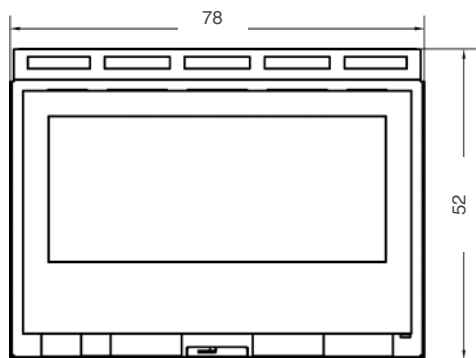

Rev. 05_2015

Τεχνικά Χαρακτηριστικά | Technical Characteristics

Διαστάσεις (Πλάτος x Βάθος x Ύψος) Dimensions (Width x Depth x Height)	78 x 50 x 52 cm
Απόδοση Efficiency	73 %
Όγκος Θέρμανσης Capacity	130 - 260 m³
Ισχύς Power	3 - 13 kw
Κατανάλωση Ξύλου Wood Consumption	1 - 3,9 kg/h
Βεντιλατέρ Ventilator	2x 140 m³/h - 28w
Διατομή Καμινάδας Smoke Outlet	Ø 20
Βάρος Weight	75 Kg

